

TA9

series

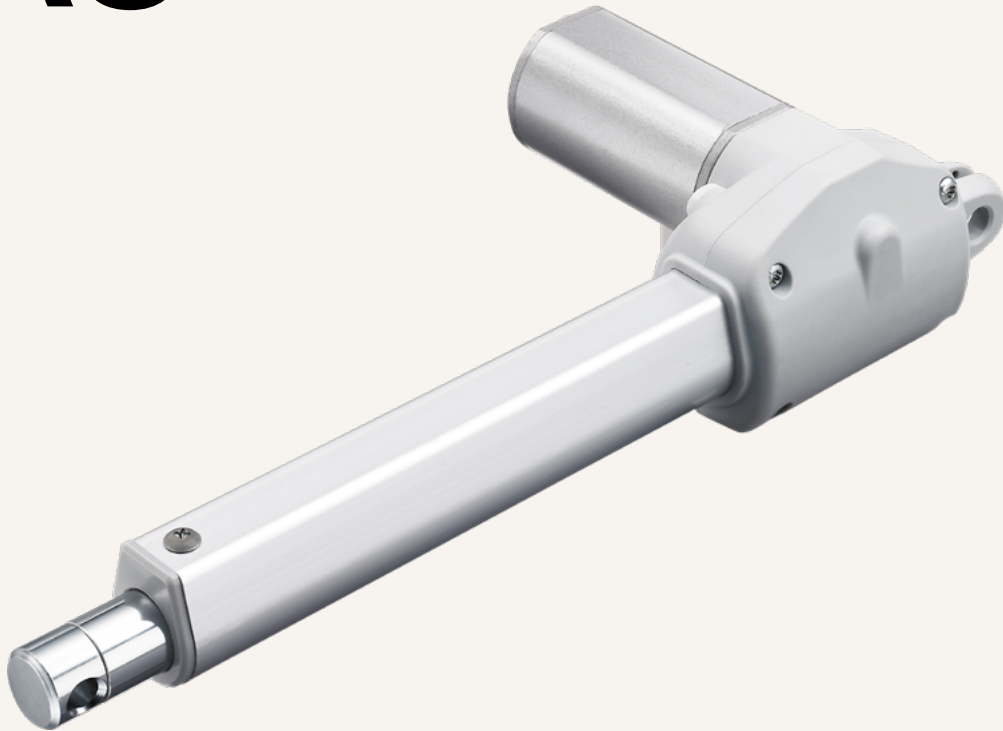

Product Segments

- **Comfort Motion**
- **Ergo Motion**

TiMOTION's TA9 is one of the smart furniture actuator options with compact dimension. This linear actuator is designed with a custom gear box, molded with a specially formulated plastic material which allows the TA9 to support load ratings up to 2500N. An EMC certification has been attained for this series, which is also available with optional IP54 or IP66 protection.

General Features

Max. load	2,500N (push); 1,000N (pull)
Max. speed at max. load	5.1mm/s
Max. speed at no load	58.3mm/s
Retracted length	≥ Stroke + 140mm
IP rating	IP66
Certificate	IEC60601-1, ES60601-1, IEC60601-1-2, UL962, EMC
Stroke	20 ~ 600mm
Options	Hall sensors
Voltage	12 / 24V DC; 12 / 24V DC (PTC)
Color	Black or grey
Operational temperature range	+5°C~+45°C

Drawing

Standard Dimensions
(mm)

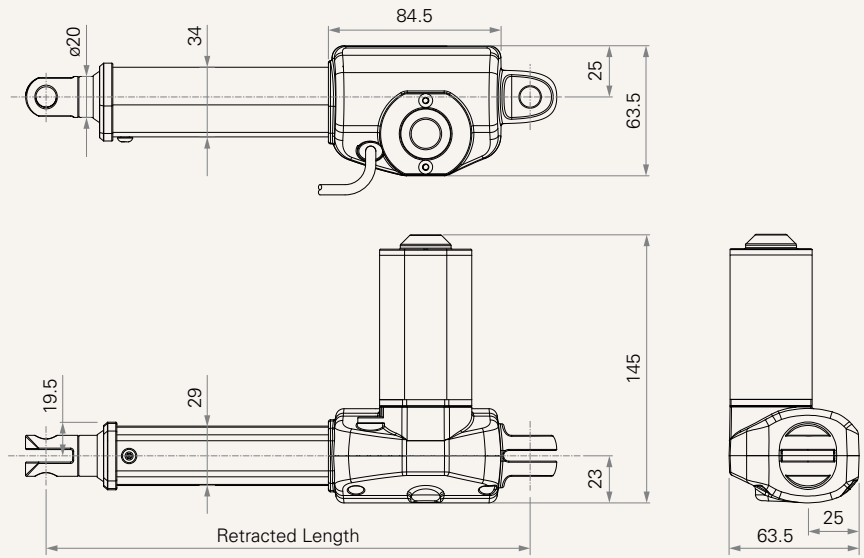

Load and Speed

CODE	Load (N)		Self Locking Force (N)	Typical Current (A)		Typical Speed (mm/s)	
	Push	Pull		No Load 32V DC	With Load 24V DC	No Load 32V DC	With Load 24V DC
Motor Speed (4100RPM, Duty Cycle 10%)							
A	2000	1000	2000	1.0	2.5	9.4	5.0
B	1500	1000	1500	1.0	2.5	13.8	6.8
C	1000	1000	1000	1.0	3.0	26.1	11.6
D	800	800	800	1.0	2.8	36.9	16.6
F	500	500	500	1.0	2.8	58.3	30.0
Motor Speed (3800RPM, Duty Cycle 10%)							
G	2500	1000	2500	1.1	2.7	9.3	5.1
H	2000	1000	2000	1.1	2.9	13.2	7.0
I	1500	1000	1500	1.1	3.5	26.0	12.5
K	1000	1000	1000	1.1	3.2	36.5	17.8
L	700	700	700	1.1	3.2	56.5	24.2
Motor Speed (3400RPM, Duty Cycle 10%)							
M	1500	1000	1500	0.8	1.6	8.1	3.8
N	1000	1000	1000	0.8	1.4	11.6	5.9
O	500	500	500	0.8	1.4	21.9	11.3
P	400	400	400	0.8	1.4	30.0	15.5
Q	300	300	300	0.8	1.4	46.5	24.0
Motor Speed (2200RPM, Duty Cycle 10%)							
V	2000	1000	2000	0.8	1.4	5.6	2.6
R	1500	1000	1500	0.8	1.4	8.1	3.7
S	1000	1000	1000	0.8	1.5	16.5	6.9
T	800	800	800	0.8	1.4	22.5	10.0
U	500	300	500	0.8	1.4	35.5	15.6

Note

- 1 Please refer to the approved drawing for the final authentic value.
- 2 This self-locking force level is reached only when a short circuit is applied on the terminals of the motor. All the TiMOTION control boxes have this feature built-in.
- 3 The current & speed in table are tested with 24V DC motor. With a 12V DC motor, the current is approximately twice the current measured in 24V DC; speed will be similar for both voltages.
- 4 The current & speed in table are tested when the actuator is extending under push load.
- 5 The current & speed in table and diagram are tested with TiMOTION control boxes, and there will be around 10% tolerance depending on different models of the control box. (Under no load condition, the voltage is around 32V DC. At rated load, the voltage output will be around 24V DC)
- 6 Standard stroke: Min. ≥ 20 mm, Max. please refer to below table.

CODE	Load (N)	Max Stroke (mm)
C, D, F, K, L, N, O, P, Q, S, T, U	≤ 1000	600
B, I, M, R	≤ 1500	500
A, H, V	≤ 2000	450
G	≤ 2500	400

Performance Data (24V DC Motor)

Motor Speed (4100RPM, Duty Cycle 10%)

Speed vs. Thrust

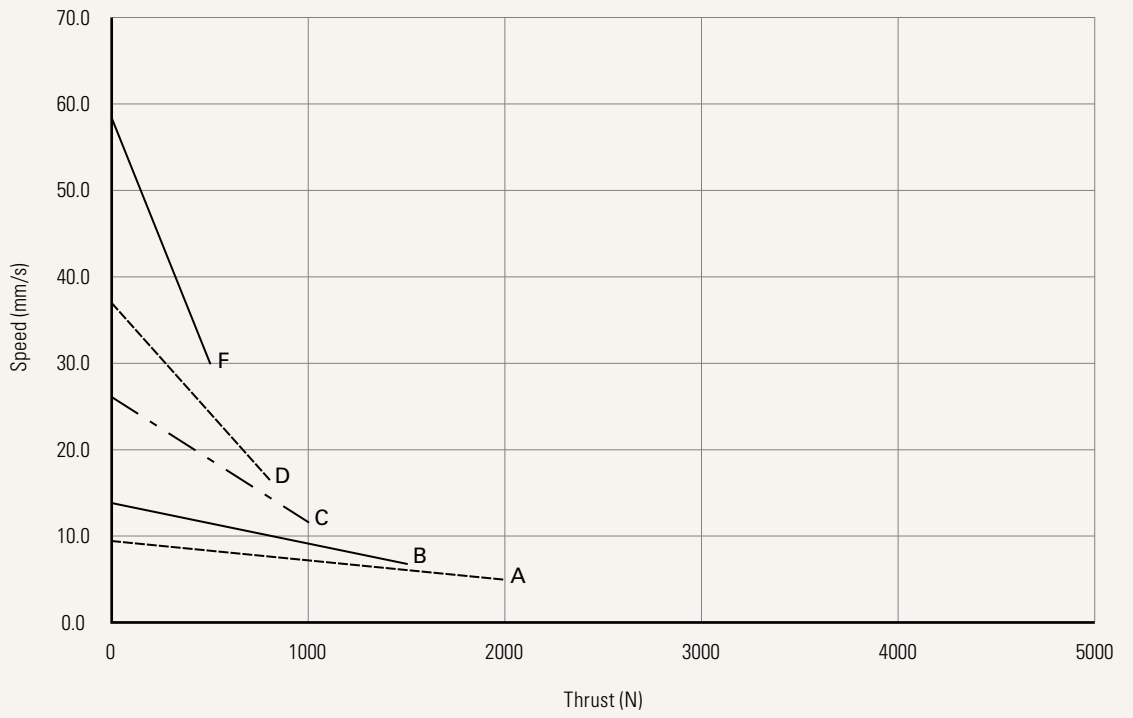

Current vs. Thrust

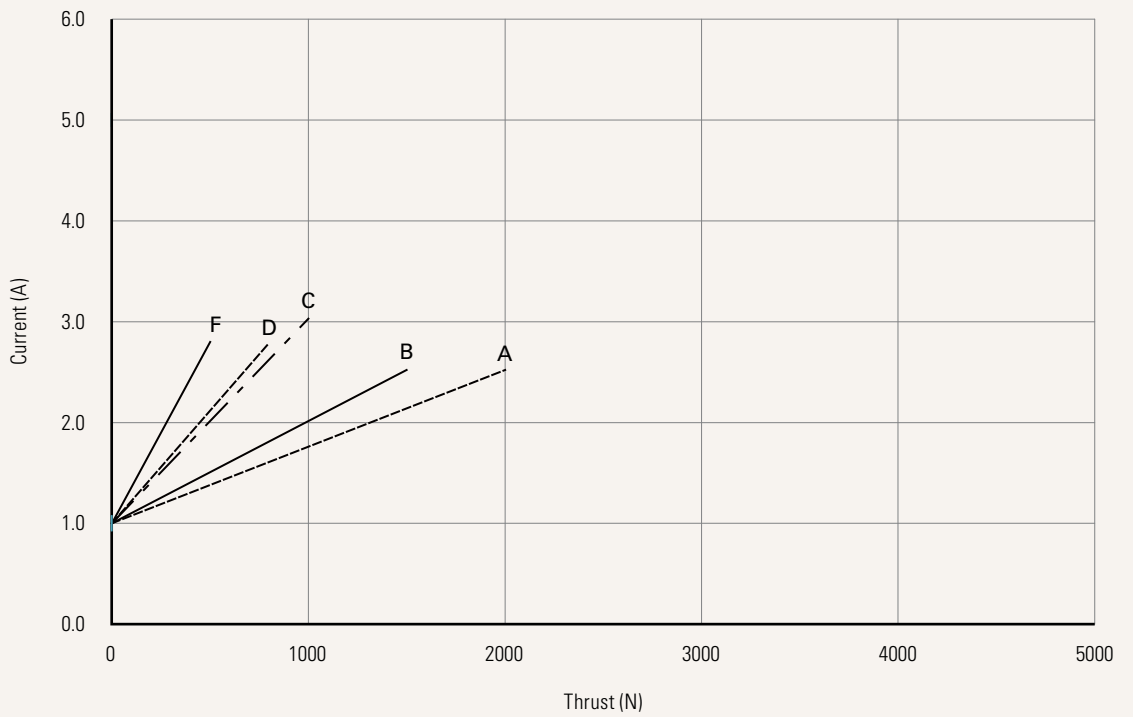

Performance Data (24V DC Motor)

Motor Speed (3800RPM, Duty Cycle 10%)

Speed vs. Thrust

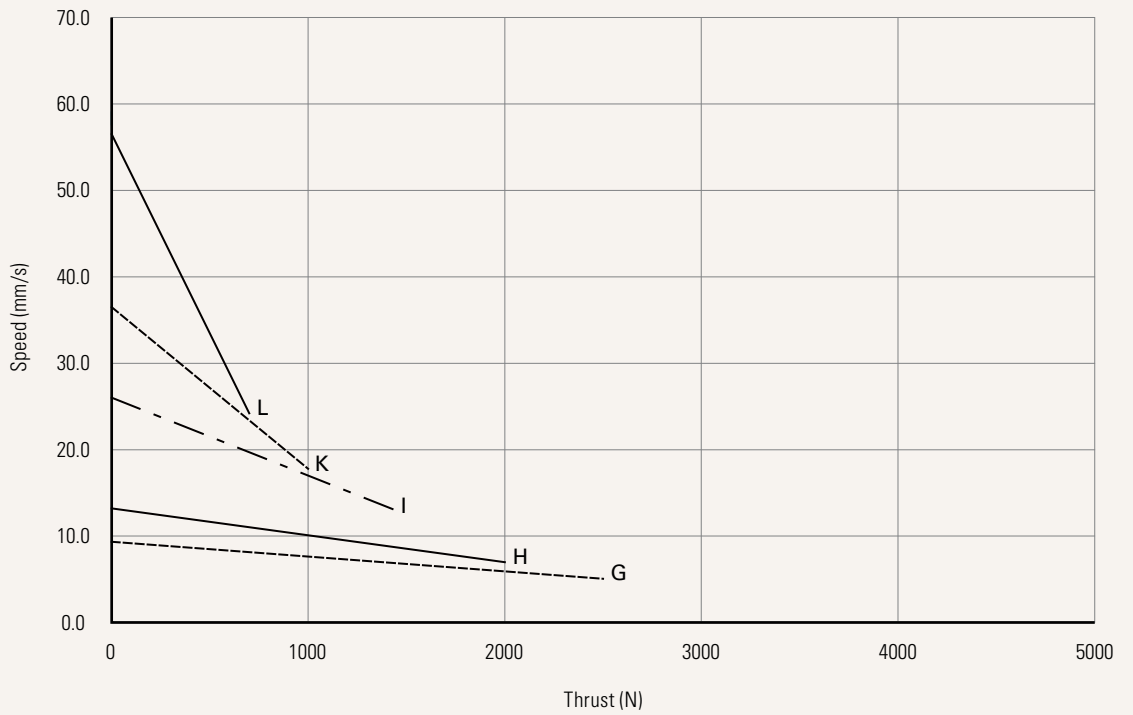

Current vs. Thrust

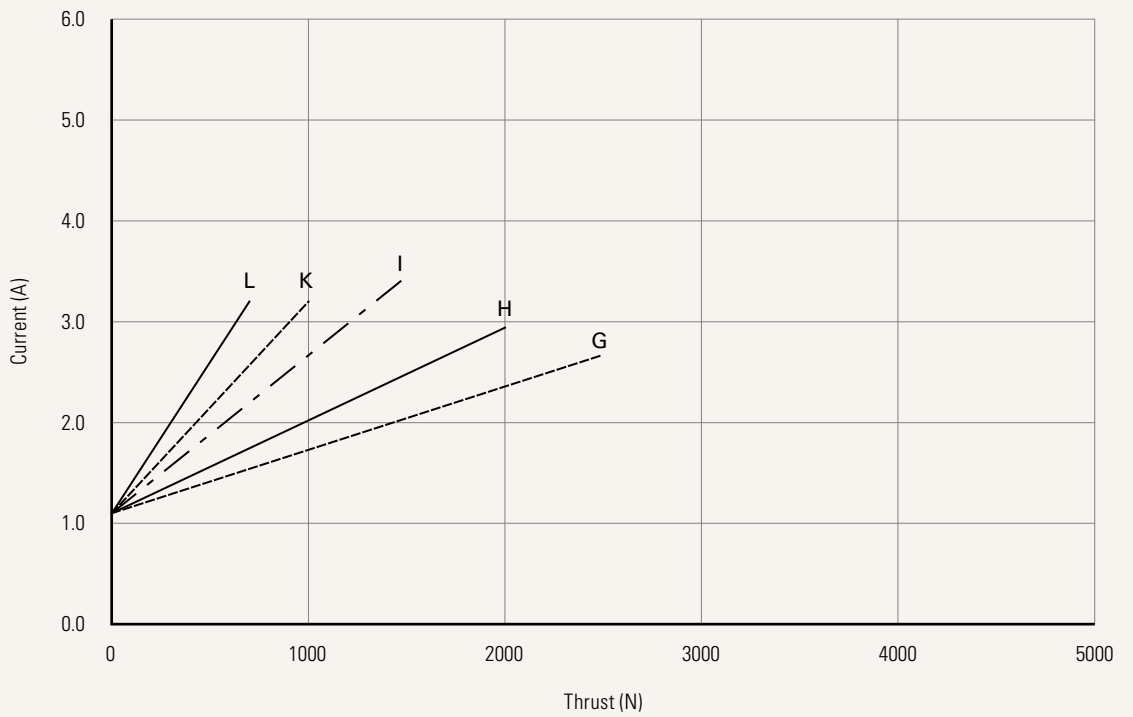

Performance Data (24V DC Motor)

Motor Speed (3400RPM, Duty Cycle 10%)

Speed vs. Thrust

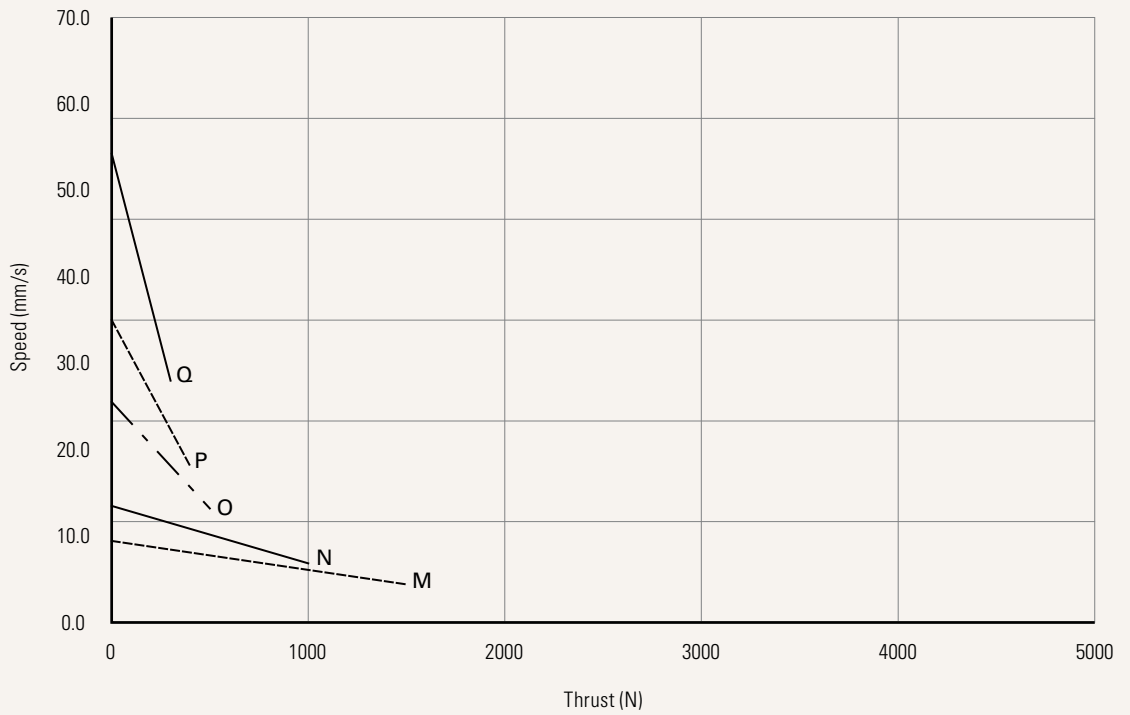

Current vs. Thrust

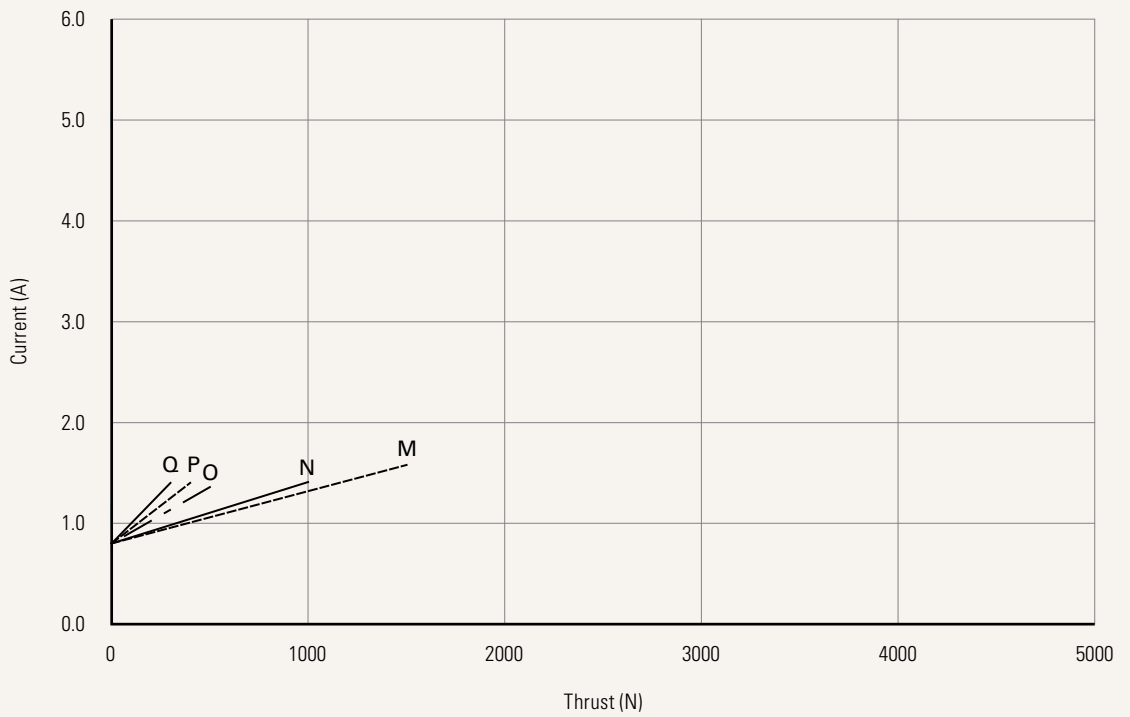

Performance Data (24V DC Motor)

Motor Speed (2200RPM, Duty Cycle 10%)

Speed vs. Thrust

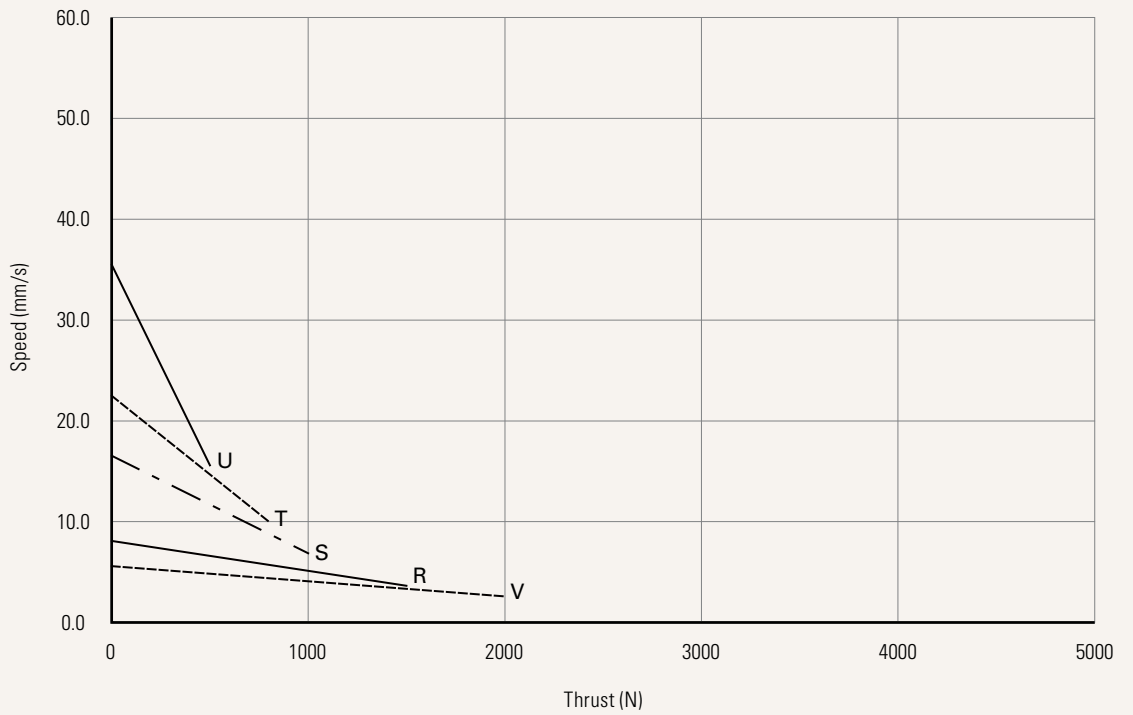

Current vs. Thrust

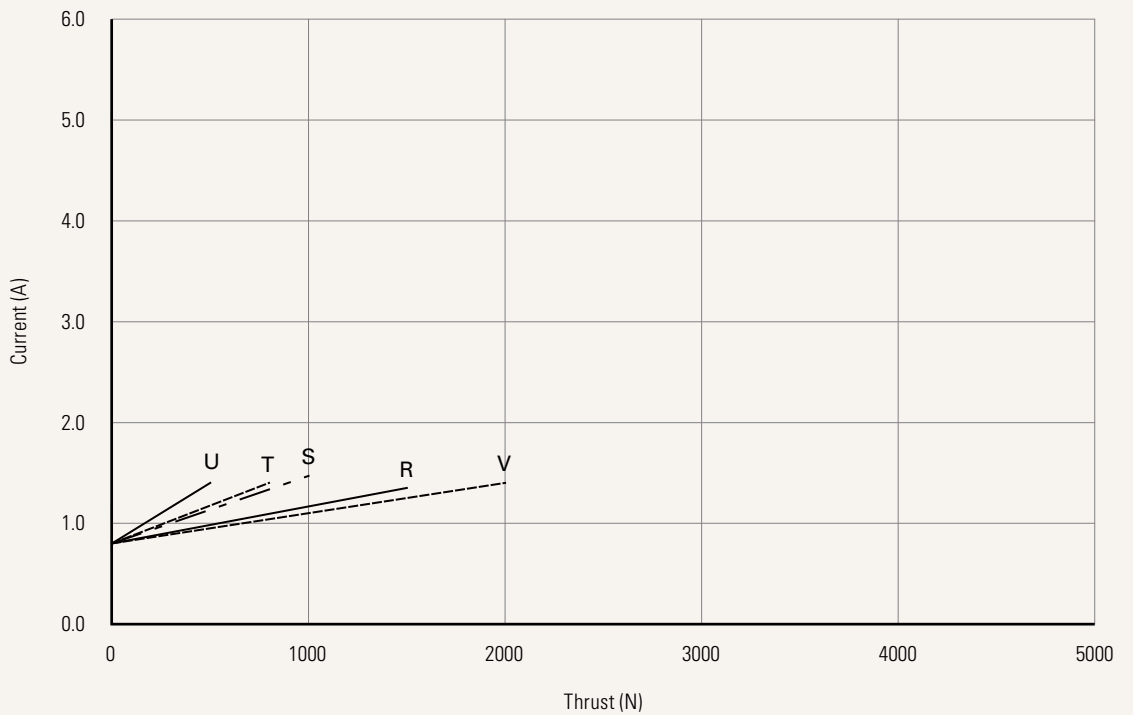

Voltage	1 = 12V DC	2 = 24V DC	5 = 24V DC, PTC	6 = 12V DC, PTC
Load and Speed	See page 3			
Stroke (mm)	See page 3			
Retracted Length (mm)	See page 9			
Rear Attachment (mm)	1 = Plastic, U clevis, slot 5.2, depth 13.0, hole 8.0, with plastic T-busing			
	See page 10			
Front Attachment (mm)	1 = Aluminum casting, no slot, hole 8.0			
	3 = Aluminum casting, U clevis, width 6.0, depth 13.0, hole 8.0			
	4 = Aluminum casting, U clevis, width 6.0, depth 13.0, hole 10.0			
	See page 10			
Direction of Rear Attachment	1 = 0°	2 = 90°		
	See page 10			
Color	1 = Black	2 = Pantone 428C		
IP Rating	1 = Without	2 = IP54	3 = IP66	
Special Functions for Spindle Sub-Assembly	0 = Without	2 = Standard push only		
Functions for Limit Switches	1 = Two switches at full retracted / extended positions to cut current			
	2 = Two switches at full retracted / extended positions to cut current + 3rd LS to send signal			
	3 = Two switches at full retracted / extended positions to send signal			
	4 = Two switches at full retracted / extended positions to send signal + 3rd LS to send signal			
	See page 11			
Output Signal	0 = Without	5 = Hall sensor * 2		
Connector	1 = DIN 6P, 90° plug	C = Y cable (for direct cut system, water proof, anti pull)		
	2 = Tinned leads	E = Molex 8P, 180° plug		
	4 = Big 01P, plug	P = Molex 8P, 90° plug, without anti-clip		
	See page 11			
Cable Length (mm)	0 = Straight, 100	3 = Straight, 1000	6 = Straight, 2000	B-H = For direct cut system
	1 = Straight, 500	4 = Straight, 1250	7 = Coiled, 200	See page 11
	2 = Straight, 750	5 = Straight, 1500	8 = Coiled, 400	

Retracted Length (mm)

1. Calculate $A+B = Y$
2. Retracted length needs to $\geq \text{Stroke}+Y$

A. Front Attach.

1, 2	+140
3, 4	+153

B. Stroke (mm)

20~200	-
201~250	+5
251~300	+10
301~350	+15
351~400	+20
401~450	+25
451~500	+30
501~550	+35
551~600	+40

Rear Attachment (mm)

1 = Plastic, U clevis, slot 5.2, depth 13.0, hole 8.0, with plastic T-busing

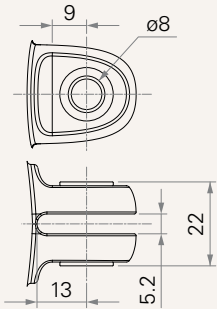

Front Attachment (mm)

1 = Aluminum casting, no slot, hole 8.0

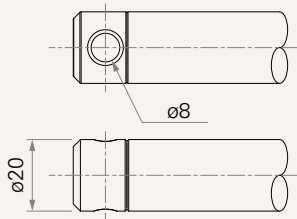

3 = Aluminum casting, U clevis, width 6.0, depth 13.0, hole 8.0

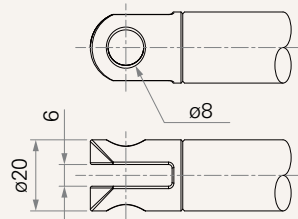

4 = Aluminum casting, U clevis, width 6.0, depth 13.0, hole 10.0

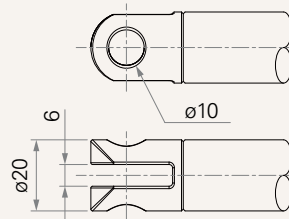

Direction of Rear Attachment

1 = 0°

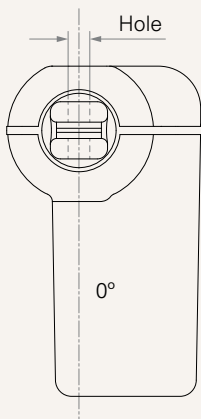

2 = 90°

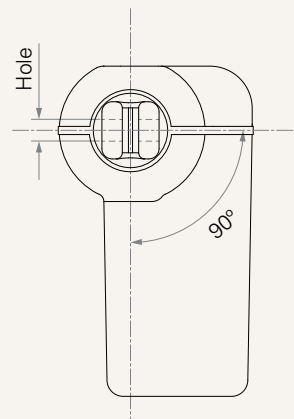

Functions for Limit Switches

Wire Definitions

CODE	Pin					
	● 1 (Green)	● 2 (Red)	○ 3 (White)	● 4 (Black)	● 5 (Yellow)	● 6 (Blue)
1	extend (VDC+)	N/A	N/A	N/A	retract (VDC+)	N/A
2	extend (VDC+)	N/A	middle switch pin B	middle switch pin A	retract (VDC+)	N/A
3	extend (VDC+)	common	upper limit switch	N/A	retract (VDC+)	lower limit switch
4	extend (VDC+)	common	upper limit switch	medium limit switch	retract (VDC+)	lower limit switch

Connector

1 = DIN 6P, 90° plug

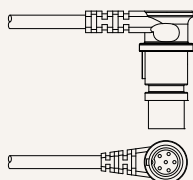

2 = Tinned leads

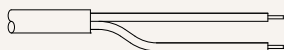

4 = Big 01P, plug

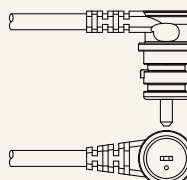

C = Y cable (For direct cut system, water proof, anti pull)

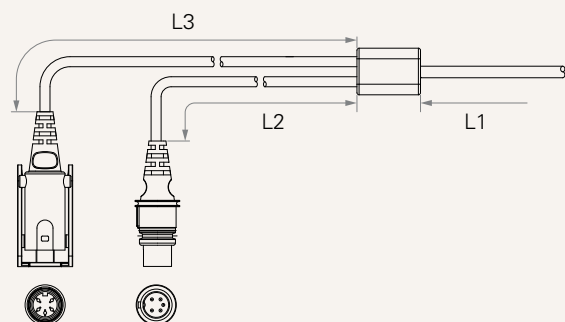

Cable length for direct cut system (mm)

CODE	L1	L2	L3
B	100	100	100
C	100	1000	400
D	100	2700	500
E	1000	100	100
F	100	600	1000
G	1500	1000	1000
H	100	100	1200

E = Molex 8P, 180° plug

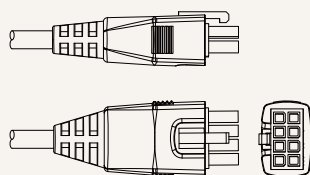

P = Molex 8P, 90° plug, without anti-clip

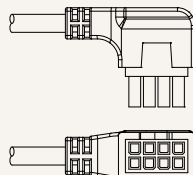

Terms of Use

The user is responsible for determining the suitability of TiMOTION products for a specific application. TiMOTION products are subject to change without prior notice.